

NPG12-75Ah

Valve-regulated lead-acid battery



DEEP CYCLE GEL SERIES

Characteristics

Nominal voltage	12V (6 cell per unit)	
Nominal capacity at 10 hours rate/10.8V (25°C)	75Ah	
Capacity (25°C)	20 Hours rate/10.8V	79.6Ah
	5 Hours rate/10.8V	62Ah
Terminal type	T14	
Torque	5.1±0.6N.m	
Approx. internal resistance (25°C)	6.0 mΩ	
Dimensions	Length	260±2mm (10.24inch)
	Width	168±2mm (6.63inch)
	Height	211±2mm (8.31inch)
	Total height	215±2mm (8.46inch)
Design Life (stand-by)	JIS at 25°C	12 years
	Eurobat at 20°C	10/12 years
Weight	24.50kg (54.01lbs)±3%	
Nominal operating temperature	25±3°C (77°F±5)	
Operating temperature range	Discharge	-15°C~50°C (5°F~122°F)
	Charge	-10°C~50°C (14°F~122°F)
	Storage	-20°C~50°C (-4°F~122°F)
Float charging voltage at 25°C	13.5V~13.8V	
Cyclic charging voltage at 25°C	14.5V~14.7V	
Temperature compensation	Float charge	-18 mV/°C/Block
	Cycle charge	-30 mV/°C/Block
Max. charging current (A)	15A	
Max. discharge current for 5 seconds	700A	
Self discharge rate (25°C)	≤3%/month	
Battery container ABS UL94-HB	V-0 optional	

Overview

NPP Power AGM GEL Series are manufactured following the highest demands in the deep cycle and renewable energy applications. The batteries use colloidal or foamed silica gel to immobilize the electrolyte, which further enhances the cycling stability. Available in top and front terminal types.

Dimensions & Terminal Type (mm)

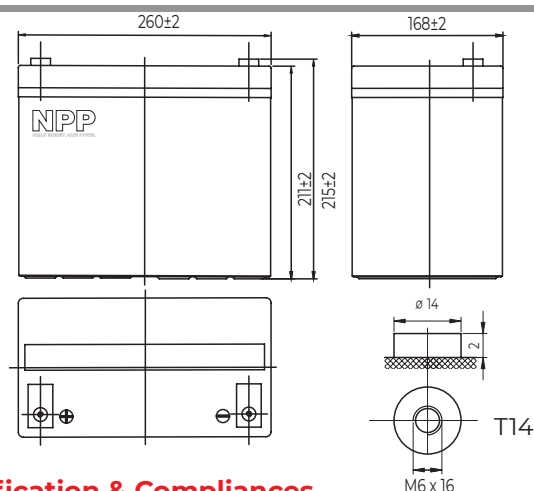

Certification & Compliances



Compliant to: EUROBAT, RoHS, WEEE's and Reach.
Manufactured according to IEC 60896-21 / 22

Construction

Component	Positive Plate	Negative plate	Container	Separator	Electrolyte	Safety valve	Terminal
Raw material	Lead dioxide	Lead	ABS (V-0 opt.)	AGM	Sulfuric Acid Gel	Rubber	Copper

Constant current discharge characteristics at 25°C

(Ampere/battery)

F.V/Time	10min	15min	30min	60min	2h	3h	4h	5h	8h	10h	20h
9.60V	146	120	72.8	45.0	27.4	19.5	15.3	13.0	9.18	7.64	4.05
9.90V	142	117	71.3	44.3	27.2	19.4	15.2	12.9	9.13	7.62	4.04
10.2V	136	113	69.1	43.2	27.0	19.3	15.1	12.8	9.06	7.60	4.03
10.5V	130	109	67.4	41.9	26.6	19.1	15.0	12.8	9.00	7.55	4.00
10.8V	123	103	65.0	40.5	25.9	18.7	14.6	12.4	8.73	7.50	3.98

Constant power discharge characteristics at 25°C

(Watts/battery)

F.V/Time	10min	15min	30min	60min	2h	3h	4h	5h	8h	10h	20h
9.60V	1580	1318	816	513	317	229	180	154	109	91.2	48.6
9.90V	1532	1286	800	505	315	228	179	153	108	91.0	48.5
10.2V	1469	1239	775	492	313	226	178	152	108	90.7	48.3
10.5V	1406	1196	757	477	308	225	176	151	107	90.2	48.0
10.8V	1327	1133	729	462	300	220	171	146	104	89.6	47.7

The above characteristics represent average values and can be obtained within three charge and discharge cycles. The batteries must be fully charged before testing. The data in this document is subject to change without notice and become contractual only after written confirmation. Please contact NPP Power for the latest available version.

NPP Power (Vietnam) Co., Ltd.

Lot A22.3, Road C4, Thanh Thanh Cong Industrial Zone,
An Hoa Ward, Trang Bang Town, Tay Ninh Province,
Vietnam

Guangzhou NPP Power Co., Ltd.

No.67 Lianglong Road, Huashan Town, Huadu District,
Guangzhou, China
Email: info@nppower.com.cn Tel. +86 20 37887 390

NPG12-75Ah

Valve-regulated lead-acid battery

DEEP CYCLE GEL

SERIES

Discharge characteristics (25°C)

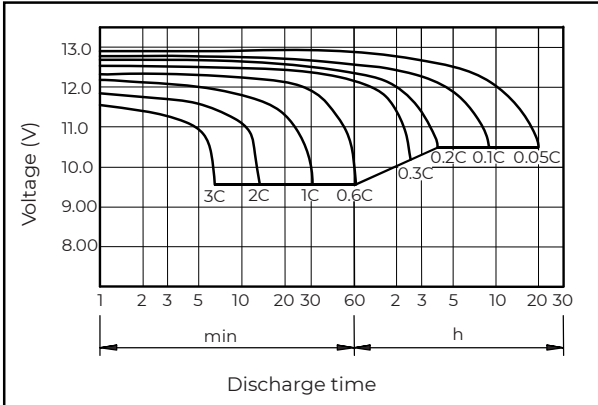

Charging characteristics (25°C)

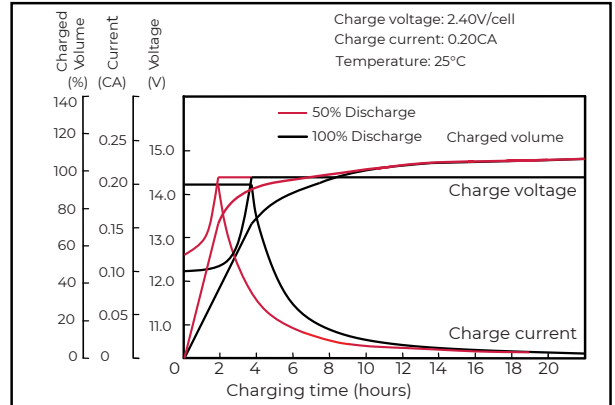

Temperature effects on capacity

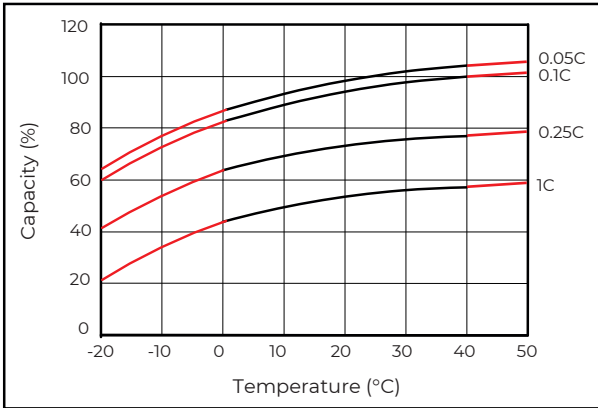

Self-discharge characteristics

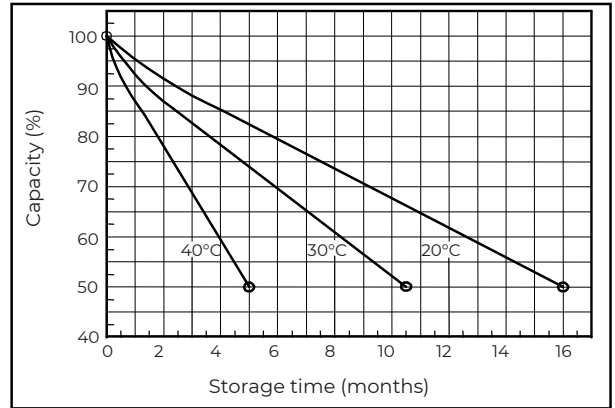

Floating life on temperature

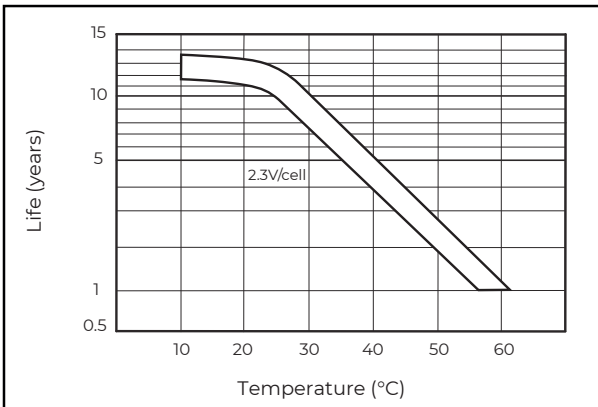

Cycle life on D.O.D (25°C)

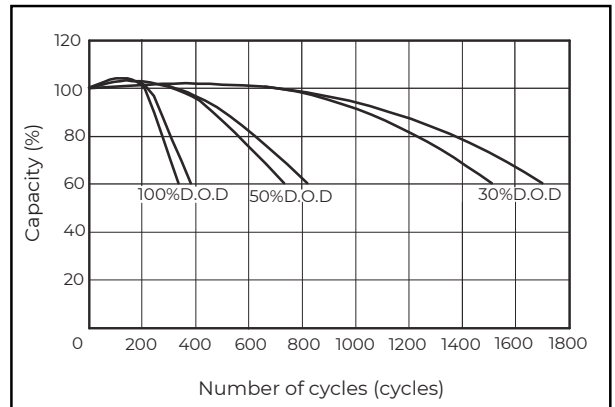

Relationship for OCV and capacity (25°C)

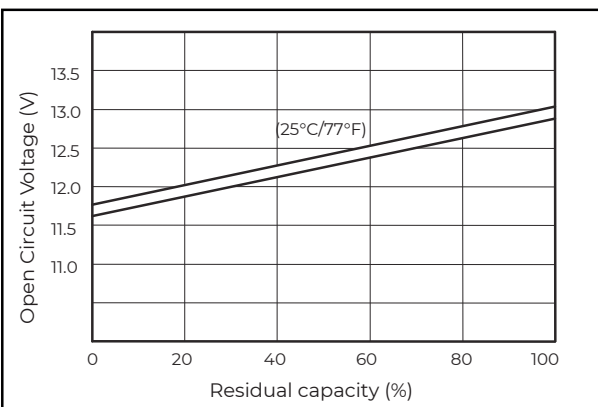

Charging voltage VS temperature

